

ISO 6431 标准气缸安装附件

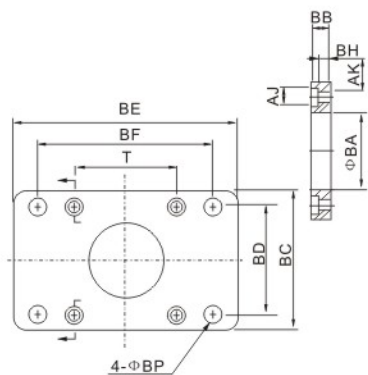

ISO-FA/FB 型 法兰板

符号/缸径	32	40	50	63	80	100	125	160	200
AJ	11	11	14	14	17	17	19	25	25
AK	7	7	9	9	11	11	13	17	17
BA	30.5	35.5	40.5	45.5	45.5	55.5	60.5	65.5	75.5
BB	10	10	12	12	16	16	20	20	25
BC	47	53	65	75	95	115	140	180	220
BD	32	36	45	50	63	75	90	115	135
BE	80	90	110	125	154	186	224	280	320
BF	64	72	90	100	126	150	180	230	270
BH	4	4	4	6	6	6	8	8	12
BP	7	9	9	9	12.5	14.5	16.5	18.5	24
T	32.5	38	46.5	56.5	72	89	110	140	175

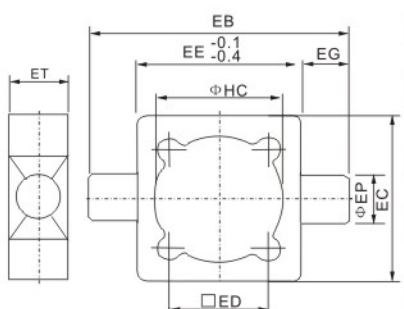

ISO-SI-TC 型中摆

符号/缸径	32	40	50	63	80	100
EB	100	113	125	140	160	182
EC	52	63	74	80	105	128
ED	32.5	38	46.5	56.5	72	89
EE	52	63	75	90	105	128
EG	25	25	25	25	25	25
EP	12	16	16	20	20	25
ET	20	22	22	28	28	34
HC	37	45	55	68	87	107.5

ISO-Y 接头

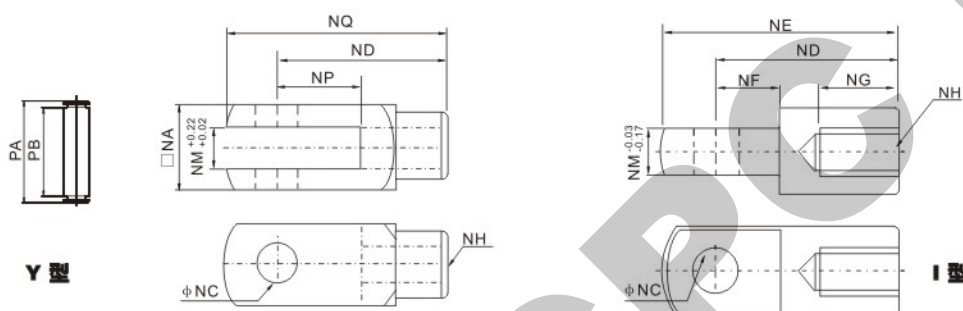

ISO-Y+销子 ISO-Y+卡扣

符号/缸径	32	40	50	63	80	100	125	160	200
NA	19	25.4	32	32	44.4	44.4	55	70	70
NC	10	12	16	16	20	20	30	35	35
ND	40	48	64	64	80	80	110	144	144
NE	52	67	89	89	112	112	155	201	201
NF	15	24	32	32	40	40	50	50	55
NG	20	20	23	23	30	30	56	72	72
NH	M10×1.25	M12×1.25	M16×1.5	M16×1.5	M20×1.5	M20×1.5	M27×2.0	M36×2.0	M36×2.0
NM	10	12	16	16	20	20	30	35	35
NP	20	24	32	32	40	40	54	72	72
NQ	52	62	83	83	105	105	148	191	191
PA	26.2	32.8	39.3	39.3	53.3	53.3	64	80	80
PB	20	26.5	33	33	45	45	55.6	70.6	70.6

ISO-I 接头



ISO 6431 标准气缸安装附件

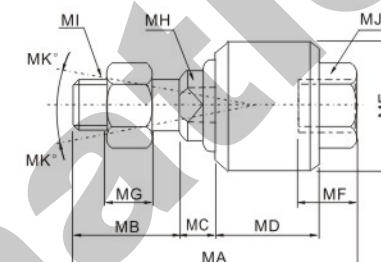

ISO-UJ 型 浮动接头

符号/缸径	MA	MB	MC	MD	ME	MF	MG	MH	MI	MK
32	58	22	7	21	26	11.5	7	10	M10×1.25	12
40	58	22	8	21	28	11.5	8	12	M12×1.25	12
50	90	27	10	41	44.5	20	10	17	M16×1.5	7
63	90	27	10	41	44.5	20	10	17	M16×1.5	7
80	102	29	13	46	53	24	13	22	M20×1.5	10
100	102	29	13	46	53	24	13	22	M20×1.5	10
125	147	54	13	64	62	39	14	30	M27×2.0	9
160	147	43	23	58	88	35	13.5	36	M36×2.0	15
200	147	43	23	58	88	35	13.5	36	M36×2.0	15

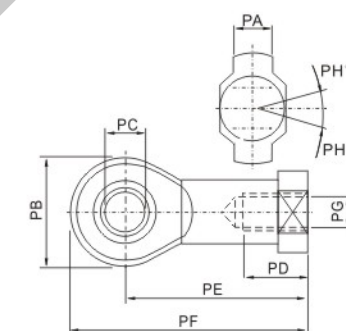
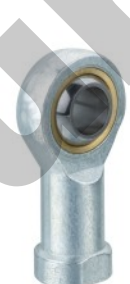

ISO-PHS 型 鱼眼接头

符号/缸径	PA	PB	PC	PD	PE	PF	PG	PH
32	11	26	10	21	43	56	M10×1.25	13
40	12	30	12	24	50	65	M12×1.25	13
50	15	38	16	33	64	83	M16×1.5	15
63	15	38	16	33	64	83	M16×1.5	15
80	18	46	20	40	77	100	M20×1.5	15
100	18	46	20	40	77	100	M20×1.5	15
125	37	70	30	51	110	145	M27×2.0	15
160	43	80	35	56	125	165	M36×2.0	16
200	43	80	35	56	125	165	M36×2.0	16

标准气缸安装附件

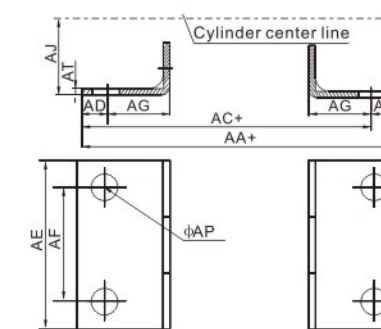

LB 型 支架

符号/缸径	32	40	50	63	80	100	125	160	200
AA	153	169	173	184	199	210	249	328	380
AC	134	140	149	158	167	174	213	288	320
AD	9.5	14.5	12	13	16	18	18	20	30
AE	50	57	68	80	97	112	140	180	220
AF	33	36	47	56	70	84	90	115	135
AG	20.5	23.5	28	31	30	30	45	60	70
AJ	28	30	36.5	41	49	57	90	115	135
AP	9	12	12	12	14	14	16	18	22
AT	3	3	3	3	4	4	8	8	10

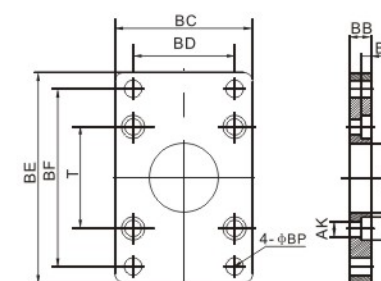

FA/FB 型 法兰板

符号/缸径	32	40	50	63	80	100	125	160	200
BA	28.3	32.3	38.3	38.3	47.3	47.3	56	63	81
BB	10	10	10	12	16	16	20	25	25
BC	47	52	65	76	95	115	140	180	220
BD	33	36	47	56	70	84	90	115	135
BE	72	84	104	116	143	162	224	280	320
BF	58	70	86	98	119	138	180	230	270
BH	6.5	6.5	6.5	8.5	10.5	10.5	15	20	20
AJ	10.5	10.5	13.5	13.5	5	5	19	25	25
AK	6.5	6.5	6.5	8.5	10.5	10.5	12.5	16.5	16.5
BP	7	7	9	9	11	11	16	18	22
T	33	37	47	56	70	84	110	140	175

标准气缸安装附件



CA 型单耳

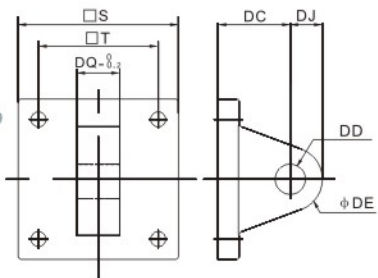

符号/缸径	32	40	50	63	80	100	125	160	200
S	48	50	62	75	94	112	140	180	220
T	33	37	47	56	70	84	110	140	175
DC	34	34	34	34	48	48	50	55	60
DD	14	14	15	15	20	20	25	30	30
DE	12	14	14	14	20	20	25	30	30
DJ	14	14	15	15	20	20	25	30	30
DQ	16	20	20	20	32	32	70	90	90



CB + Pin 型双耳

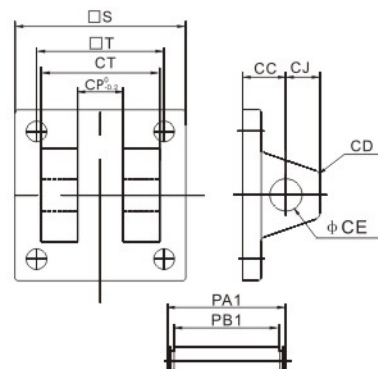

符号/缸径	32	40	50	63	80	100	125	160	200
CC	19	19	19	19	32	32	50	55	60
CD	5	5	3	2	8	8	25	30	30
CE	12	14	14	14	20	20	25	30	30
CJ	13	13	15	15	21	21	25	30	30
CP	16	20.5	20.3	20.3	32.3	32.3	70	90	90
CT	32	44	52	52	64	64	120	160	160
PA1	41	51.8	60.3	60.3	73.8	73.8	130	170	170
PB1	33.5	45.8	54	54	65.5	65.5	121.5	161.5	161.5
S	48	50	62	75	94	94	140	180	220
T	33	37	47	56	70	70	110	140	175

■ 从缸径 32-100的CA和CB, 我们可以提供2种不同材质的产品, 1.铁 2.铝, 请在下订单时标明材质, 从125-200 全部为铁。

标准气缸安装附件



TC 型中摆

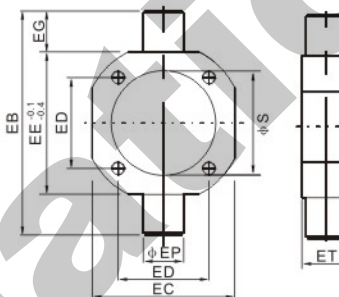

符号/缸径	40	50	63	80	100	125	160	200
EB	113	126	138	164	182	210	264	336
EC	63	76	88	114	132	160	200	240
ED	37	47	56	70	84	110	140	175
EE	63	76	88	114	132	160	200	240
EG	25	25	25	25	25	25	32	48
EP	25	25	25	25	25	25	32	37
ET	30	30	30	30	40	30	38	44
S	45.5	55.5	68.5	87.5	107.5	134.5	172.5	212.5



TC-M 型中摆+脚座

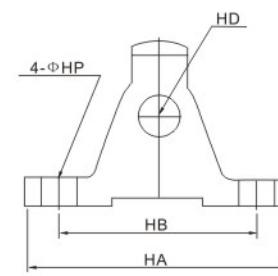

符号/缸径	HA	HB	HC	HD	HE	HF	HI	HJ	HQ	HR	HT	HP
40	110	80	45.5	22	109	86	81.5	50	23	2	12	12
50	110	80	55.5	22	122	99	88	50	23	2	12	12
63	110	80	68.5	22	134	111	94	50	23	2	12	12
80	120	85	87.5	22	160	137	127	70	23	2	14	14
100	120	85	107.5	22	178	155	136	70	23	2	14	14

迷你气缸安装附件



M-UJ 型浮动接头

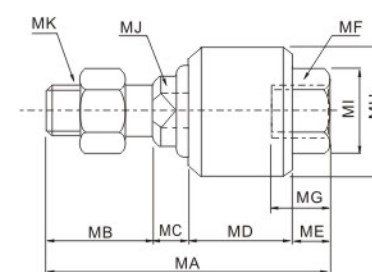

符号/缸径	MA	MB	MC	MD	ME	MF	MG	MH	MI	MJ	MK
20	51	20	6	17	8	M8×1.25	12	24	13	8	M8×1.25
25	58	22	7	21	8	M10×1.25	12	26	17	10	M10×1.25
32	58	22	7	21	8	M10×1.25	12	26	17	10	M10×1.25
40	58	22	8	21	7	M12×1.25	12	28	19	12	M12×1.25



M-PHS 型鱼眼接头

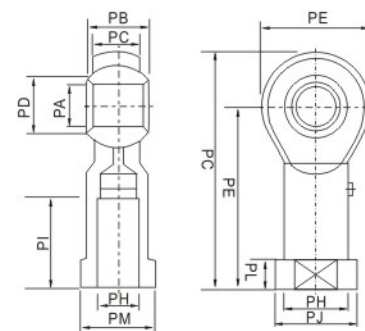

符号/缸径	PA	PB	PC	PD	PE	PF	PG	PH	PI	PJ	PK	PL	PM
20	8	12	9	10.4	22	36	47	M8×1.25	17	16	12.5	5	14
25	10	14	11	12.9	26	43	56	M10×1.25	21	19	15	6.5	17
32	10	14	11	12.9	26	43	56	M10×1.25	21	19	15	6.5	17
40	12	16	12	15.4	30	50	65	M12×1.25	24	22	17.5	6.5	19



Y+销子型接头

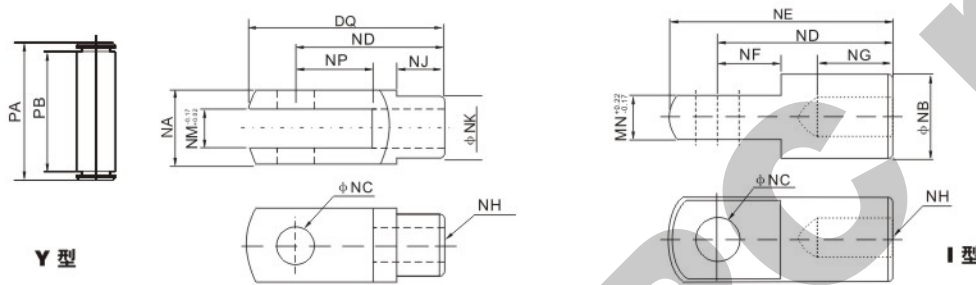

Symbol/Bore	32	40	50	63	80	100	125	160	200
NA	19	25.4	32	32	44.4	44.4	55	80	80
NB	20	24	32	32	40	40	45	54	54
NC	10	12	16	16	20	20	25	30	30
ND	40	48	64	64	80	80	110	120	120
NE	52	67	89	89	112	112	155	130	130
NF	15	24	32	32	40	40	40	35	35
NG	20	20	23	23	30	30	56	50	50
NH	M10×1.25	M12×1.25	M16×1.5	M16×1.5	M20×1.5	M20×1.5	M27×2	M36×2	M36×2
NJ	12	20	22	22	30	30	30	40	40
NK	18	23	30	30	39	39	54	54	54
NM	10	12	16	16	20	20	48	40	40
MP	20	24	32	32	40	40	64	35	35
NQ	52	62	83	83	105	105	148	150	150
PA	25	32.8	39.3	39.3	53.3	53.3	64	91	91
PB	19.5	26.5	33	33	45	45	55	81	81

I 型接头